

# Kit 1109

**NISSAN Mistral**, 3-dr SUV, 93-06

**NISSAN Mistral**, 5-dr SUV, 93-06

**NISSAN Terrano II**, 3-dr SUV, 93-02, 03-

**NISSAN Terrano II**, 5-dr SUV, 93-02, 03-

**FORD Maverick**, 3-dr SUV, 93-99

**FORD Maverick**, 5-dr SUV, 93-99

**KIA Sportage**, 3-dr SUV, 96-03

**KIA Sportage**, 5-dr SUV, 94-03, 04-

480R  
754

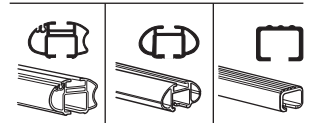
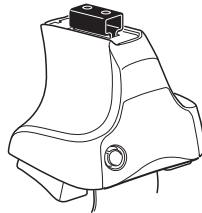

480

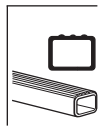
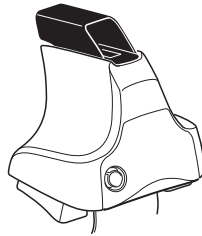

750

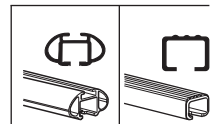
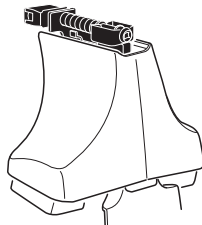

|                      |    |                      |          |    |
|----------------------|----|----------------------|----------|----|
|                      |    |                      |          |    |
| x2<br>x2<br>x2<br>x4 | x2 | x2<br>x2<br>x4<br>x4 | x2<br>x2 | x2 |

177 x 4

16 x 4

x 1

**Kit**

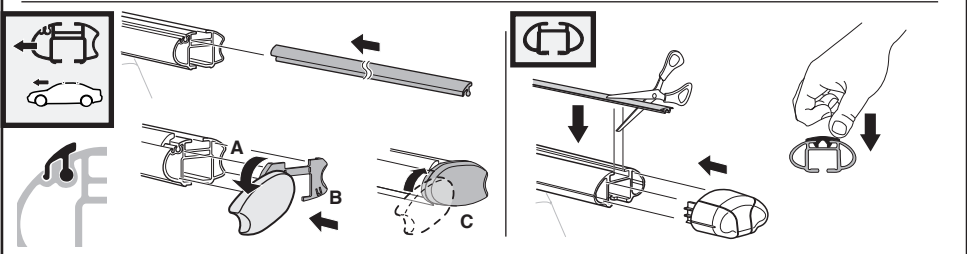
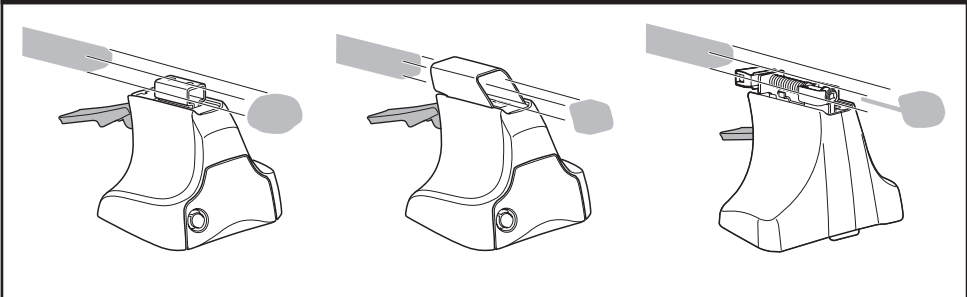

3

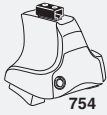

754

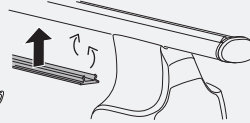
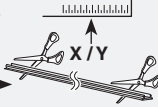

750

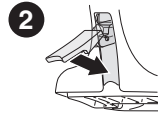
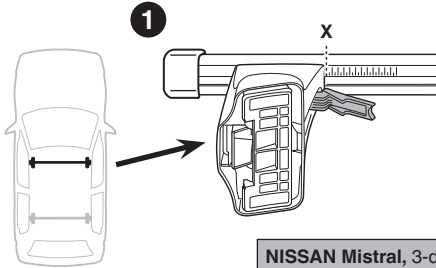

|                                                | X           |
|------------------------------------------------|-------------|
| <b>NISSAN Mistral, 3-dr SUV, 93-06</b>         | <b>33,5</b> |
| <b>NISSAN Mistral, 5-dr SUV, 93-06</b>         | <b>33,5</b> |
| <b>NISSAN Terrano II, 3-dr SUV, 93-02, 03-</b> | <b>33,5</b> |
| <b>NISSAN Terrano II, 5-dr SUV, 93-02, 03-</b> | <b>33,5</b> |
| <b>FORD Maverick, 3-dr SUV, 93-99</b>          | <b>33,5</b> |
| <b>FORD Maverick, 5-dr SUV, 93-99</b>          | <b>33,5</b> |
| <b>KIA Sportage, 3-dr SUV, 96-03</b>           | <b>31</b>   |
| <b>KIA Sportage, 5-dr SUV, 94-03, 04-</b>      | <b>31</b>   |

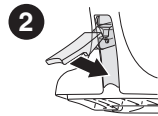
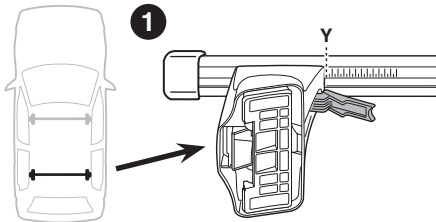

|                                                | Y           |
|------------------------------------------------|-------------|
| <b>NISSAN Mistral, 3-dr SUV, 93-06</b>         | <b>33,5</b> |
| <b>NISSAN Mistral, 5-dr SUV, 93-06</b>         | <b>32</b>   |
| <b>NISSAN Terrano II, 3-dr SUV, 93-02, 03-</b> | <b>33,5</b> |
| <b>NISSAN Terrano II, 5-dr SUV, 93-02, 03-</b> | <b>32</b>   |
| <b>FORD Maverick, 3-dr SUV, 93-99</b>          | <b>33,5</b> |
| <b>FORD Maverick, 5-dr SUV, 93-99</b>          | <b>32</b>   |
| <b>KIA Sportage, 3-dr SUV, 96-03</b>           | <b>28,5</b> |
| <b>KIA Sportage, 5-dr SUV, 94-03, 04-</b>      | <b>28,5</b> |

**3**



480R



480

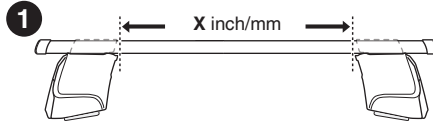
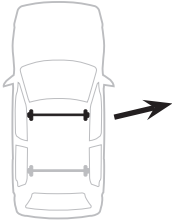

|                                         | X inch                           | X mm |
|-----------------------------------------|----------------------------------|------|
| NISSAN Mistral, 3-dr SUV, 93-06         | 38 <sup>7</sup> / <sub>8</sub> " | 986  |
| NISSAN Mistral, 5-dr SUV, 93-06         | 38 <sup>7</sup> / <sub>8</sub> " | 986  |
| NISSAN Terrano II, 3-dr SUV, 93-02, 03- | 38 <sup>7</sup> / <sub>8</sub> " | 986  |
| NISSAN Terrano II, 5-dr SUV, 93-02, 03- | 38 <sup>7</sup> / <sub>8</sub> " | 986  |
| FORD Maverick, 3-dr SUV, 93-99          | 38 <sup>7</sup> / <sub>8</sub> " | 986  |
| FORD Maverick, 5-dr SUV, 93-99          | 38 <sup>7</sup> / <sub>8</sub> " | 986  |
| KIA Sportage, 3-dr SUV, 96-03           | 37 <sup>7</sup> / <sub>8</sub> " | 961  |
| KIA Sportage, 5-dr SUV, 94-03, 04-      | 37 <sup>7</sup> / <sub>8</sub> " | 961  |

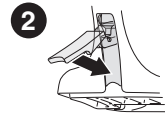
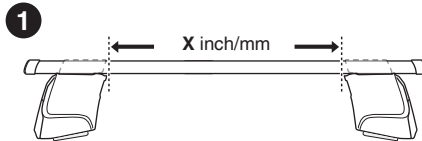
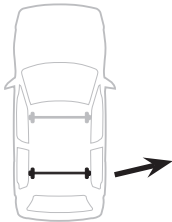

|                                         | X inch                           | X mm |
|-----------------------------------------|----------------------------------|------|
| NISSAN Mistral, 3-dr SUV, 93-06         | 38 <sup>7</sup> / <sub>8</sub> " | 986  |
| NISSAN Mistral, 5-dr SUV, 93-06         | 38 <sup>1</sup> / <sub>4</sub> " | 971  |
| NISSAN Terrano II, 3-dr SUV, 93-02, 03- | 38 <sup>7</sup> / <sub>8</sub> " | 986  |
| NISSAN Terrano II, 5-dr SUV, 93-02, 03- | 38 <sup>1</sup> / <sub>4</sub> " | 971  |
| FORD Maverick, 3-dr SUV, 93-99          | 38 <sup>7</sup> / <sub>8</sub> " | 986  |
| FORD Maverick, 5-dr SUV, 93-99          | 38 <sup>1</sup> / <sub>4</sub> " | 971  |
| KIA Sportage, 3-dr SUV, 96-03           | 36 <sup>7</sup> / <sub>8</sub> " | 936  |
| KIA Sportage, 5-dr SUV, 94-03, 04-      | 36 <sup>7</sup> / <sub>8</sub> " | 936  |

# 4

NISSAN Mistral, 3-dr SUV, 93-06

NISSAN Terrano II, 3-dr SUV, 93-02, 03-

FORD Maverick, 3-dr SUV, 93-99

KIA Sportage, 3-dr SUV, 96-03

## SRA

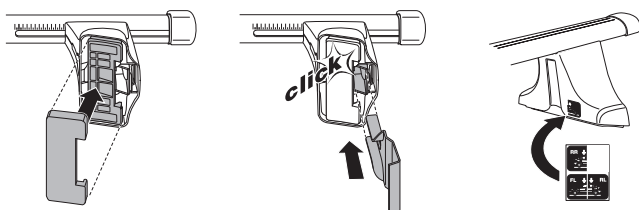
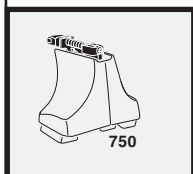
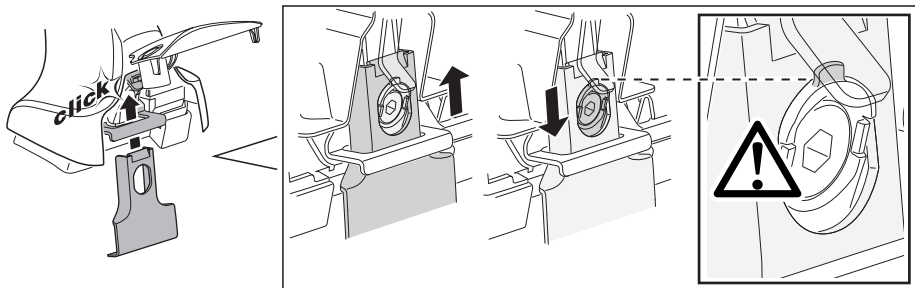
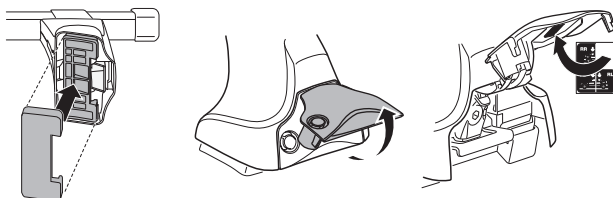
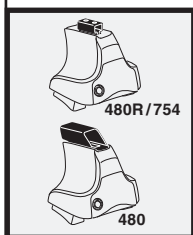
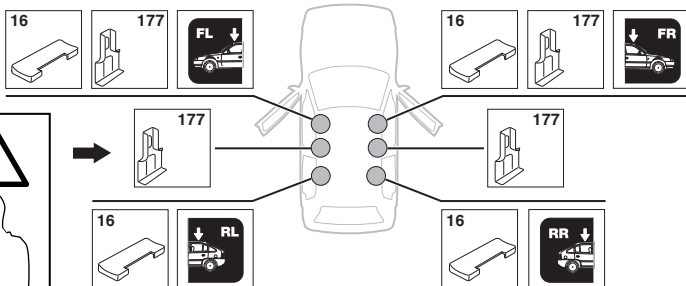
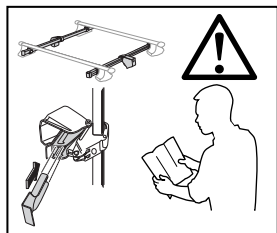

# 4

NISSAN Mistral, 5-dr SUV, 93-06

NISSAN Terrano II, 5-dr SUV, 93-02, 03-

FORD Maverick, 5-dr SUV, 93-99

KIA Sportage, 5-dr SUV, 94-03, 04-

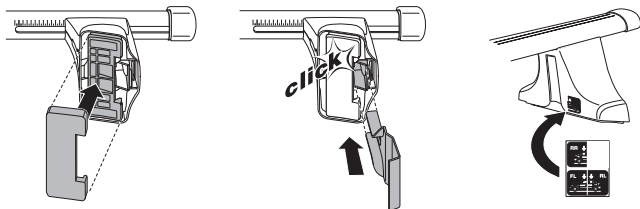
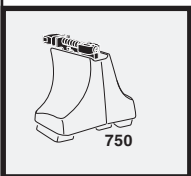
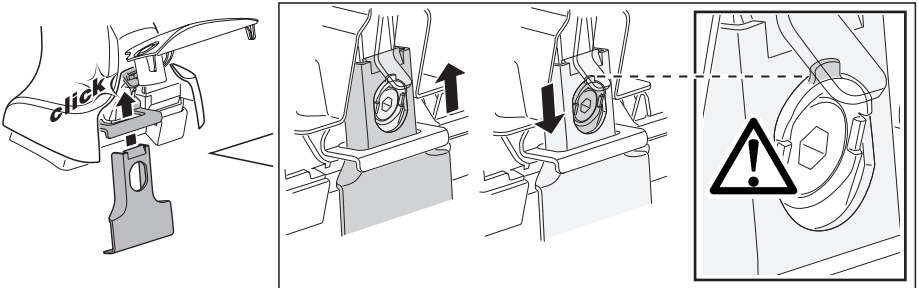
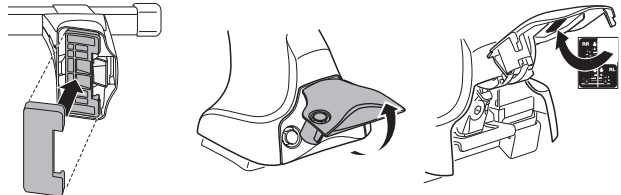
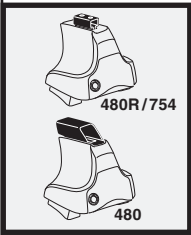
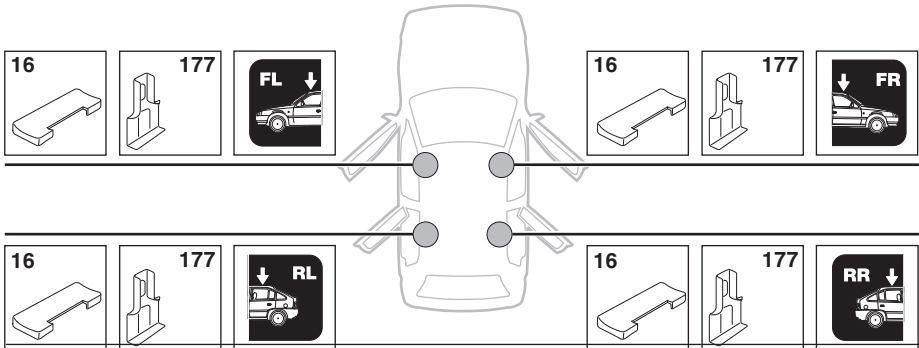

5

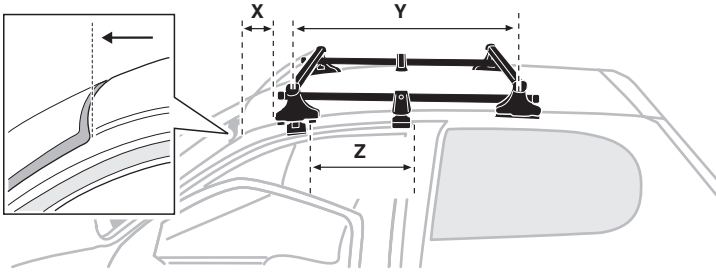
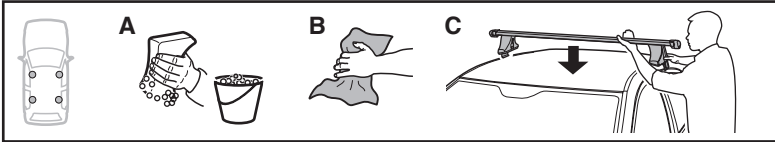

|                                                 | X mm   | Y mm   | Z mm   | X inch | Y inch  | Z inch  |
|-------------------------------------------------|--------|--------|--------|--------|---------|---------|
| <b>NISSAN Mistral</b> , 3-dr SUV, 93-06         | 180 mm | 700 mm | 290 mm | 7 1/8" | 27 1/2" | 11 3/8" |
| <b>NISSAN Terrano II</b> , 3-dr SUV, 93-02, 03- | 180 mm | 700 mm | 290 mm | 7 1/8" | 27 1/2" | 11 3/8" |
| <b>FORD Maverick</b> , 3-dr SUV, 93-99          | 180 mm | 700 mm | 290 mm | 7 1/8" | 27 1/2" | 11 3/8" |
| <b>KIA Sportage</b> , 3-dr SUV, 96-03           | 220 mm | 700 mm | 330 mm | 8 5/8" | 27 1/2" | 13"     |

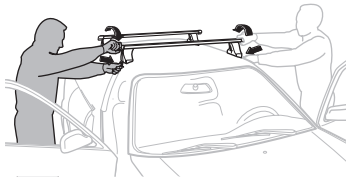
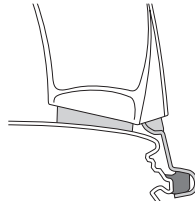

**GB/US** Tighten alternately

**D** Die Schrauben abwechselnd anziehen

**F** Serrer alternativement chaque côté

**NL** Afwisselend aan de linker- en de rechterkant aandraaien

**I** Alternare il serraggio delle viti

**E** Serrare alternativamente

**PT** Aperte alternadamente

**S** Dra åt växelvis

**FIN** Kierrä vuorotellen

**EST** Pinguldage vaheldumisi

**LAT** Pielvelciēt pamišus

**LIT** Užsukinėkite pakaitomis

**PL** Śruby dokręcaj naprzemiennie

**RU** Затягивайте попеременно

**CZ** Pokręťta bāgažnika dokręcaj dokręcaj naprzemiennie.

**SK** Doťahujte striedavo

**SLO** Privijajte izmenično.

**HR** Naizmjenično zategnite

**HU** Egymástól függetlenül szorítandó

**GR** Σφιγγετε εναλλάξ

**TR** Dönüşümlü sıkın

**中文** 交替拧紧

**한국어** 번갈아 가며 조이십시오.

**日本語** 交互に締め付けてください。

**ไทย** ชับในแบบสลับ



5

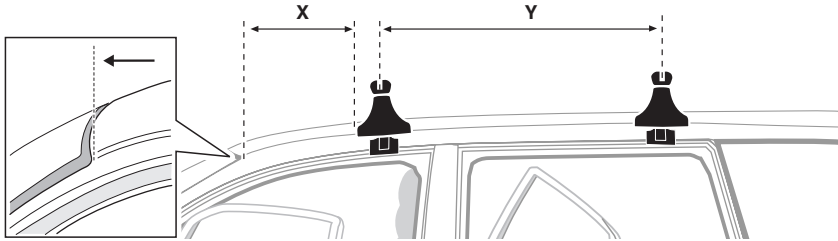
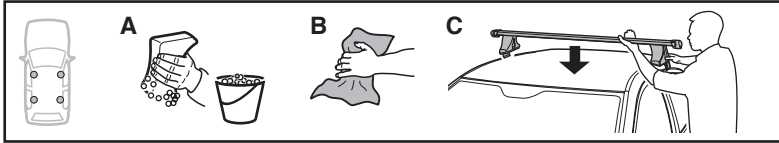

|                                         | X mm   | Y mm   | X inch  | Y inch  |
|-----------------------------------------|--------|--------|---------|---------|
| NISSAN Mistral, 5-dr SUV, 93-06         | 180 mm | 700 mm | 7 1/8"  | 27 1/2" |
| NISSAN Terrano II, 5-dr SUV, 93-02, 03- | 180 mm | 700 mm | 7 1/8"  | 27 1/2" |
| FORD Maverick, 5-dr SUV, 93-99          | 180 mm | 700 mm | 7 1/8"  | 27 1/2" |
| KIA Sportage, 5-dr SUV, 94-03, 04-      | 270 mm | 700 mm | 10 5/8" | 27 1/2" |

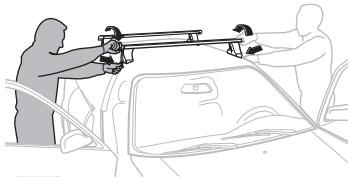
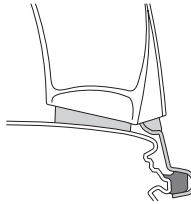

- GB/US** Tighten alternately
- D** Die Schrauben abwechselnd anziehen
- F** Serrer alternativement chaque côté
- NL** Afwisselend aan de linker- en de rechterkant aandraaien
- I** Alternare il serraggio delle viti
- E** Serrare alternativamente
- PT** Aperte alternadamente
- S** Dra åt växelvis

- FIN** Kierrä vuorotellen
- EST** Pinguldage vaheldumisi
- LAT** Pielieciet pamišus
- LIT** Užsukinėkite pakaitomis
- PL** Śruby dokręcaj naprzemiennie
- RU** Затягивайте попеременно
- CZ** Pokręťta багаžníka dokręcaj dokręcaj naprzemiennie.
- SK** Doťahujte striedavo
- SLO** Privijajte izmenično.
- HR** Naizmjenično zategnite
- HU** Egymástól függetlenül szorítandó
- GR** Σφίγγετε εναλλάξ
- TR** Dönüşümlü sıkın
- 中文** 交替拧紧
- 한국어** 번갈아 가며 조이십시오.
- 日本語** 交互に締め付けてください。
- ไทย** ขันในแบบสลับ

6

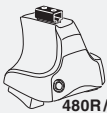

480R/754



480

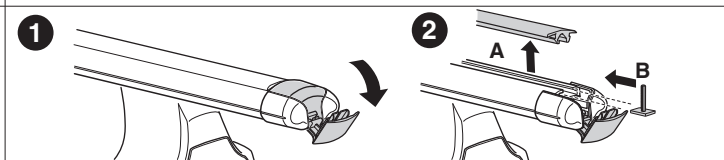
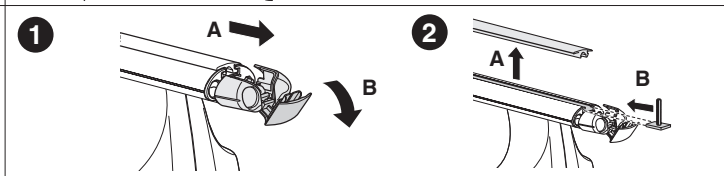
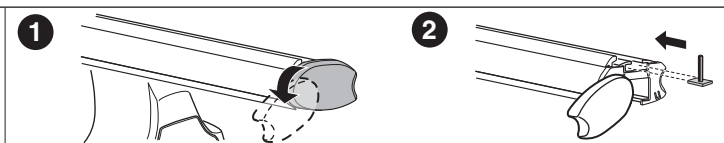
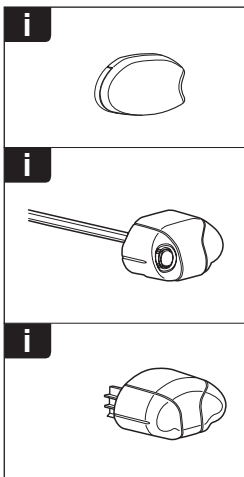
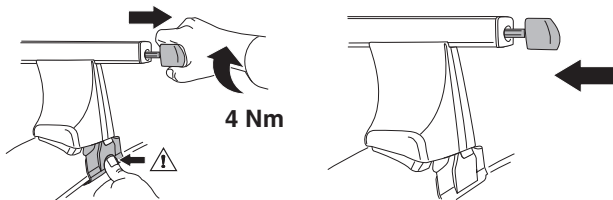
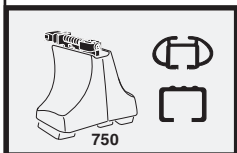
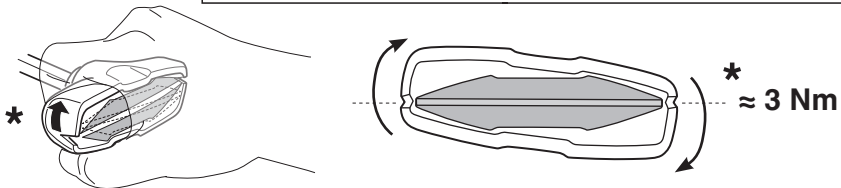
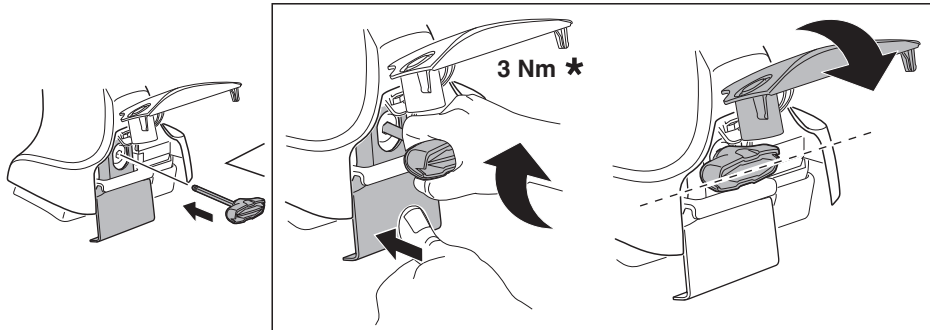



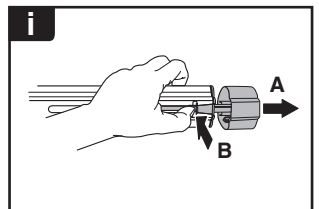
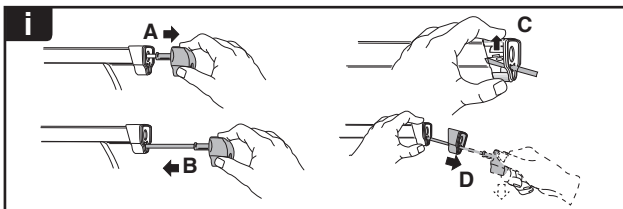
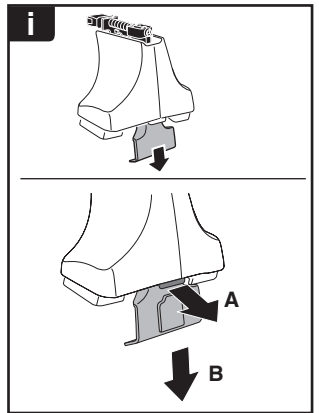
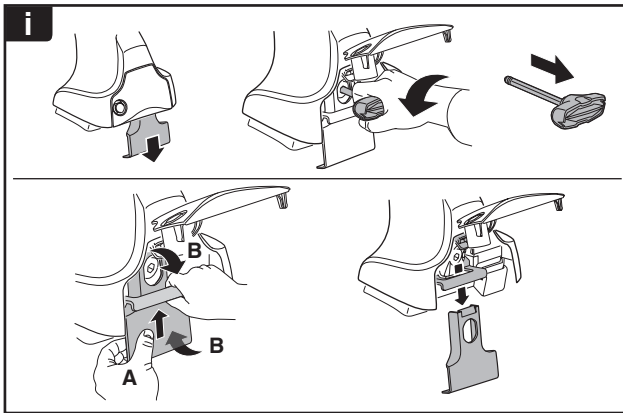
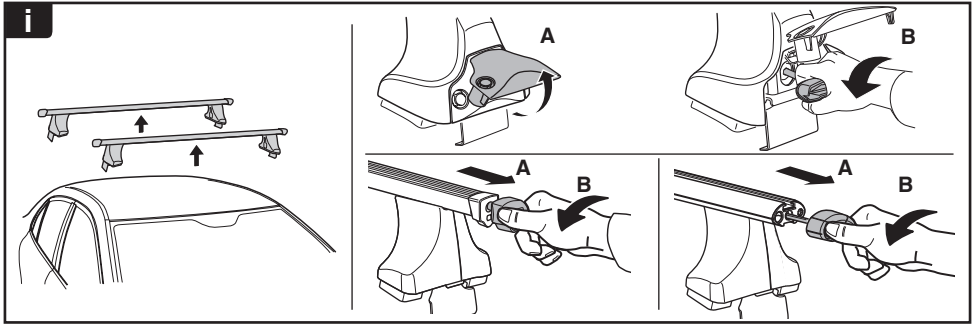

**THULE**  
SWEDEN  
**ONE  
KEY  
SYSTEM**

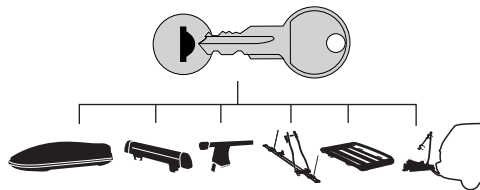

- 544 (x4)
- 596 (x6)
- 588 (x8)
- NA 510 (x10)
- EUR 452 (x12)
- ASIA

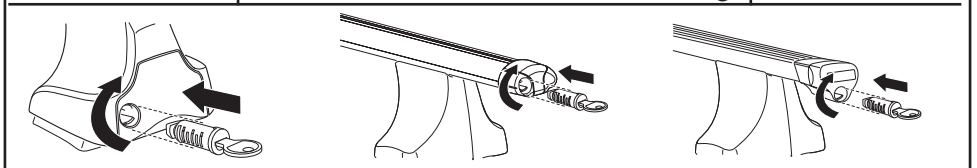

WW ▶ Thule Sweden AB, Box 69, 330 33 Hillerstorp, SWEDEN  
NA ▶ Thule Inc., 42 Silvermine Road, Seymour, Connecticut 06483, USA

info@thule.com  
customer.service@thule.com

www.thule.com